

Veterinary Radiographic System

HF X-Ray Generator

OPERATOR'S MANUAL

Part Number 07186 Rev. H

Introduction	1	➤
<hr/>		
Safety	2	➤
<hr/>		
General Product Overview	3	➤
<hr/>		
Operation of Unit	4	➤
<hr/>		
Error Codes	5	➤
<hr/>		
Editing APR	6	➤
<hr/>		
Technical Data	7	➤
<hr/>		
Generator Exposure Tables	8	➤
<hr/>		
Troubleshooting	9	➤
<hr/>		
Scheduled Maintenance	10	➤
<hr/>		
Cleaning	11	➤
<hr/>		

Operator's Manual Revisions History

Revision	Pages Affected/Revision Description	Release Date	ECR #
A	Initial release	May, 2015	8684
B	Updated Error Codes Table with errors E59 to E67	October, 2016	9254
C	Updated address to Niles, IL	July, 2017	9607
D	Updated Output Parameters. Updated Error Codes Table with errors E68 to E70	July, 2018	9965
E	Updated Output Parameters Tables	October, 2018	10045
F	Updated Output Parameters Tables. Added errors E71 to E74 to Error Codes Table. Added X-ray Tube Seasoning for weekly maintenance.	February, 2020	10398
G	Updated Section 4.7, ROUTINE MAINTENANCE, and Section 9.1; Added Editing APR section; Renumbered Sections.	February, 2021	10705
H	Updated X-ray Tube Seasoning procedure for weekly maintenance.	August, 2023	11275

1.0 INTRODUCTION

Congratulations on your purchase of the Veterinary Radiographic System with HF generator. This line represents a new concept in veterinary radiography by being the first system to incorporate the x-ray generator into the table. This major innovation led to other significant design breakthroughs yielding the most practical, efficient and compact unit ever created. The result of this innovation and improvement is the X-ray System you have purchased.

Because the X-ray System is so unique, its features and functions are a bit different from those of traditional x-ray systems. The purpose of this manual is to familiarize you with the X-ray System and assist you with operating and maintaining your new system. The manual is divided into indexed sections for quick and easy access to information.

Should a situation arise which cannot be resolved through the troubleshooting procedures described in this manual, please contact the Summit dealer where you purchased your machine for assistance, or call Summit directly at 1-800-972-9776.

GENERATOR MAIN FEATURES:

- Full 125 kVp output capability
- Smaller, lighter modular design
- Constant dose output due to kVp and mA regulation during exposure
- User-friendly controls
- Extensive self-diagnostics

This information is provided to help you establish safe operating conditions for both you and your X-ray system.

Do not operate this X-ray system except in accordance with information included in this section, and any additional information provided by the X-ray system manufacturer and/or competent safety authorities.

Address any question regarding X-ray system operation to:

Mail: Customer Support Department
Summit Industries LLC
7555 N. Caldwell Ave.
Niles, IL 60714

Telephone: (800) 729-9729 or (773) 588-2444

Fax: (773) 588-3424
Attention: Customer Support Department



2.0 SAFETY

2.1 INSTALLATION

The X-ray System must be installed and serviced by an authorized Summit dealer. All warranties will be void if such installation or service is performed by persons not authorized by Summit.

2.2 OPERATION

2.2.1 Safety Symbols

	<p>Warning symbol used to indicate a potential hazard to operators, service personnel or to the equipment. It indicates a requirement to refer to the accompanying documentation for details.</p>
	<p>Radiation exposure symbol used on operator console. Lights to indicate that an exposure is in progress. This is accompanied by an audible tone from the console.</p>
 <p><u>WARNING:</u> THIS X-RAY UNIT MAY BE DANGEROUS TO PATIENT AND OPERATOR UNLESS SAFE EXPOSURE FACTORS AND OPERATING INSTRUCTIONS ARE OBSERVED.</p>	<p>Radiation warning label on console. Never allow unqualified personnel to operate the X-ray generator.</p>

WARNING:



PROPER USE AND SAFE OPERATING PRACTICES WITH RESPECT TO X-RAY GENERATORS AND EQUIPMENT ARE THE RESPONSIBILITY OF THE USERS OF SUCH EQUIPMENTS. SUMMIT INDUSTRIES LLC. PROVIDES INFORMATION ON ITS PRODUCTS AND ASSOCIATED HAZARDS, BUT ASSUMES NO RESPONSIBILITIES FOR AFTER-SALE OPERATING AND SAFETY PRACTICES.

SUMMIT INDUSTRIES LLC ACCEPTS NO RESPONSIBILITY FOR ANY X-RAY EQUIPMENT NOT MAINTAINED OR SERVICED ACCORDING TO THE SERVICE AND INSTALLATION MANUAL OR ANY EQUIPMENT THAT HAS BEEN MODIFIED IN ANY WAY.

SUMMIT INDUSTRIES LLC ALSO ASSUMES NO RESPONSIBILITY FOR X-RAY RADIATION OVEREXPOSURE OF PATIENTS OR PERSONNEL RESULTING FROM POOR OPERATING TECHNIQUES OR PROCEDURES.

X-ray radiation exposure may be damaging to health, with some effects being cumulative and extending over periods of many months or even years. **X-ray operators should avoid any exposure to the primary beam** and take protective measures to safeguard against scatter radiation. Scatter radiation is caused by any object in the path of the primary beam and may be of equal or less intensity than the primary beam that exposes the film.

No practical design can incorporate complete protection for operators or service personnel who do not take adequate safety precautions. **Only authorized and properly trained service and operating personnel should be allowed to work with this X-ray generator and equipment.** The appropriate personnel must be made aware of the inherent dangers associated with the servicing of high voltage equipment and the danger of excessive exposure to X-ray radiation during system operation.

- Use of protective wear with an equivalent of a minimum of 0.5 mm of lead is recommended.
- Keep as large a distance as possible away from the object being exposed and the X-ray tube assembly.
- Never operate this X-ray equipment in areas where there is a risk of explosion. Detergents and disinfectants, including those used on patients, may create explosive mixtures of gases. Please observe the relevant regulations.
- Only authorized, trained service staff may remove the covers of the generator and equipment.

2.2.2 Electrical



Do not connect unauthorized equipment to the rear of the console. INCORRECT CONNECTIONS OR USE OF UNAPPROVED EQUIPMENT MAY RESULT IN INJURY OR EQUIPMENT DAMAGE.



DO NOT EXCEED THE TUBE MAXIMUM OPERATING LIMITS SHOWN IN THE X-RAY TUBE DATA. INTENDED LIFE AND RELIABILITY WILL NOT BE OBTAINED UNLESS GENERATORS ARE OPERATED WITHIN PUBLISHED SPECIFICATIONS.

Only properly trained and qualified personnel should be permitted access to any internal parts. Live electrical terminals may be deadly. Be sure line disconnect switches are opened and other appropriate precautions are taken before opening access doors, removing enclosure panels, or attaching accessories.

Do not remove the flexible high-tension cables from the x-ray tube housing or high-tension generator or the access covers from the generator until the main and auxiliary power supplies have been disconnected.

When disconnecting high-voltage cables, they must be grounded immediately in order to dissipate any electrical charge that may remain on the cables or the tube.

Failure to comply with the foregoing may result in serious or potentially fatal bodily injuries to the operator or those in the area.

2.2.3 Mechanical

All of the movable assemblies and parts of x-ray equipment should be operated with care. Only properly trained and qualified personnel should be permitted access to any internal parts.

Particular care should be taken when servicing the inside of the tubestand. There is an extreme threat of mechanical pinching between the vertical slide and counterweight due to their close proximity and opposite directions of motion.

3.0 GENERAL PRODUCT OVERVIEW

3.1 MAJOR COMPONENTS

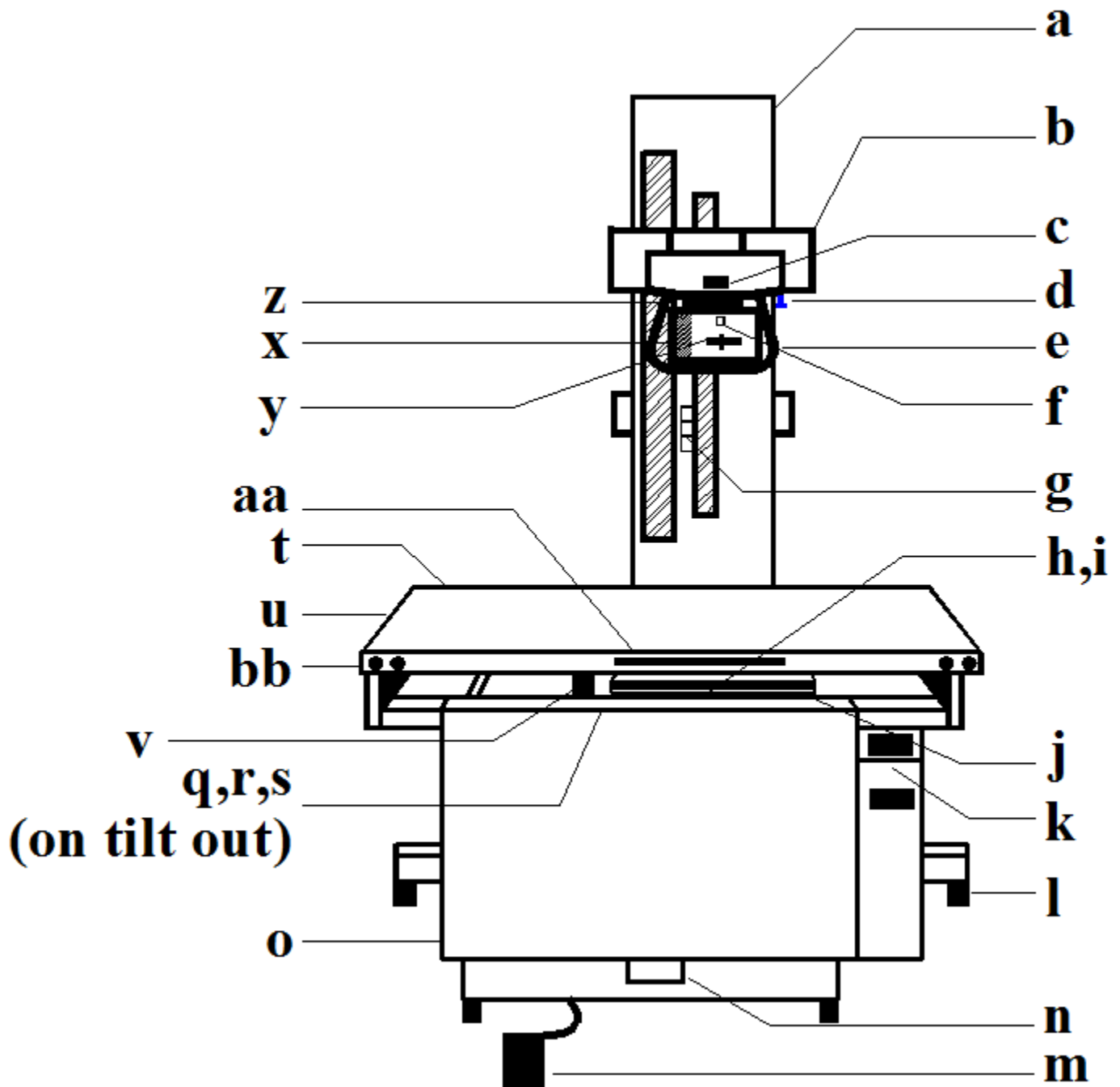

- a. Tubestand: Supports collimator and x-ray tube. Moves both horizontally and vertically.
- b. X-Ray Tube
- c. kVp/mAs Systems:
 - Angulation Dial - displays degree of x-ray tube angulation.
 - AP Systems:
 - Operator's Console – displays patient views, technique recommendations and angle of x-ray beam in degrees. (Appearance may vary from model to model.)
- d. Angulation lock - when loosened, allows angulation of x-ray tube.
- e. Handle Bars - used to move tube vertically or to angle the tube.
- f. Light Switch Button - Turns collimator bulb on and off.
- g. Source-Image Distance (SID) Indicator - When marker aligns with label on tubestand, SID (the distance between the tube focal spot and the film) is 40". There is a position for tabletop work and one for grid cabinet applications.
- h. Grid Cabinet - Lead-lined cabinet holds cassette tray and grid.
- i. Grid, mounted to upper carriage of grid cabinet, absorbs scatter radiation for improved film clarity.
- j. Cassette Tray - Molded indentations hold cassettes in correct position.
- k. Cassette Storage Box (Optional) - Opens to store cassettes. Lead lined to protect film.
- l. Rustproof Support Feet - They adjust to level the table.
- m. Exposure Foot Switch - Used to make exposures.
- n. Release Foot Pedal - When depressed, opens front of table to access control panel.
- o. Table Base - all steel, welded construction.
- q. kVp Controls and digital display – allows for adjustment from 40 to 125 kVp (1 kVp increments).
- r. mA Control - Adjusts mA: 50 and 100 when using small tube focal spot and 200, 300, 350, 400, 450 and 500 when using large focal spot.
- s. mAs Control and display – Allows for adjustment from 0.2 to 400 mAs.
- t. Drain Trough - minimizes spillage behind table.
- u. Table Top (optional float table top) - 24" x 53" of Formica (33" x 57" of Formica).
- v. Tubestand/Grid Cabinet Interlock - When engaged, allows tubestand, grid cabinet and cassette tray to move together.
- x. Collimator - Controls size and rectangular shape of primary beam emitted from x-ray tube and provides coincident light field.
- y. Shutter Adjustment Knobs - One each to determine width and depth of primary beam.
- z. Swivel Mounting Plate - Allows collimator to be rotated.
- aa. Lamp Switches (optional) – Turns collimator bulb on and off. Located on the front and both ends of the table.
- bb. Float Top Unlock Button (optional) - Located on the front of the table at both corners.

4.0 OPERATION OF UNIT

4.1 GETTING STARTED

- 4.1.1 Opening Unit - Depress the Release Foot Pedal to open the front access door.
- 4.1.2 Power Switch – Press the ON button on the operator control panel. It is a good idea to turn the unit off at the end of each day. This ultimately will extend your system's life. If desired, the system can be programmed to turn itself off if not used within a specific amount of time. It can be set for 1-10 hours in 1 hour increments, or disabled. Contact your Summit dealer to program this feature.
- 4.1.3 Warm up - It is recommended that you warm up the unit prior to the first higher-powered exposure to prolong tube life. This is done by taking a series of three exposures using the 300 mA station set at 30 mAs. Start with a kVp of 70 and increase to 80, then 90. Exposures should be spaced at least 20 seconds apart.
- 4.1.4 Storing Cassettes - Cassettes can be stored in the optional storage box or boxes mounted to either side of the table.
- 4.1.5 Loading Cassettes - Three sizes of cassettes can be used: 8" x 10", 10" x 12" and 14" x 17". Simply position the cassette into the specially-formed grooves of the tray. It will accept the cassette either lengthwise or crosswise.
- 4.1.6 Removing Cassettes – The cassette tray has special openings in the underside to allow the cassette to be lifted out of the indentions for easy removal with gloved hands.

IMPORTANT: Although the storage box is lead-lined, it will not protect film from fogging after excessive exposure.

4.2 POSITIONING THE TUBE

- 4.2.1 Moving Grid/Grid Cabinet - The grid/grid cabinet can be moved in tandem with the tubestand, assuring alignment of the primary beam to the center of the film. The grid cabinet can be positioned anywhere along the entire length of the table. Grasp the handle bars and move the tubestand to the desired location.
- 4.2.2 Disengaging the Grid Cabinet - Alternatively, the grid cabinet may be moved independent of the tubestand. Release the interlock by sliding the spring-loaded lever extending from the grid cabinet to the left. The grid cabinet may then move while the tubestand remains stationary. To re-engage the interlock, position grid cabinet in-line with tubestand. The interlock is engaged when you hear a metallic "click" sound and feel the interlock mechanism move into place.
- 4.2.3 Vertical Movement - The tube can be moved from 9-1/2" to 40" above the table top. For convenience, the SID markers indicate 40" positions from the table top or the grid cabinet. During vertical motion, you will note a pause at one height, which is the pre-set height for optimal exposure, set by adjusting the detents during setup and calibration. If you prefer another pre-set height (detent position) contact your Summit dealer.
- 4.2.4 Float Top (option) - Push in float top unlock button and move the table. Release the button to lock the top position.
- 4.2.5 Angulation – Release the lock, which is located on the right side of the tube arm. Grasp the handle bars and rotate the tube to proper angle. Turn the lock handle clockwise to hold tube position. The degree of rotation is indicated by the dial located between the handle bars.

4.3 COLLIMATOR OPERATION

- 4.3.1 Light Field - Once the tube is positioned relative to the grid cabinet, press the light button on the front of the collimator or one of the "NO HANDS" (option) collimator switches on the front or ends of the table. A light field will appear. **WARNING! DO NOT LOOK DIRECTLY INTO LIGHT SOURCE AS RETINA DAMAGE COULD RESULT.**
- 4.3.2 Programmable Lamp Times - Lamp gradually turns off in one of the following times: 30, 60, 90, or 120 seconds. The factory setting is 90 seconds. If you push the button during the lamp's power down ramp, a new ramp down cycle starts. When the no hands option is chosen, selectable light ramp down is also furnished.
- 4.3.3 Without the programmable light option, the light will remain on for 90 seconds, then turn itself off. If the light button is pressed again within the 90-second time frame, the light will be extinguished.
- 4.3.4 Shutter Adjustment - Use the sliding knobs to move shutters. Scales indicate knob positions that correspond to common cassette sizes. Use the pointer to quickly move shutters into relative position, then fine tune to collimate beam to area of radiographic interest.
- 4.3.5 Swivel movement - When doing table top work, you may want to swivel the collimator to avoid awkward patient positioning. Hold the collimator and rotate it about its center axis. **WARNING: Do not touch the black lamp cover at the rear of the collimator as it gets quite hot.** You will note that the collimator hesitates at the 0° and 90° positions. This is in order to help find this position accurately.

4.4 USER CONSOLE: KVP/MAS

OPERATOR CONTROL PANEL

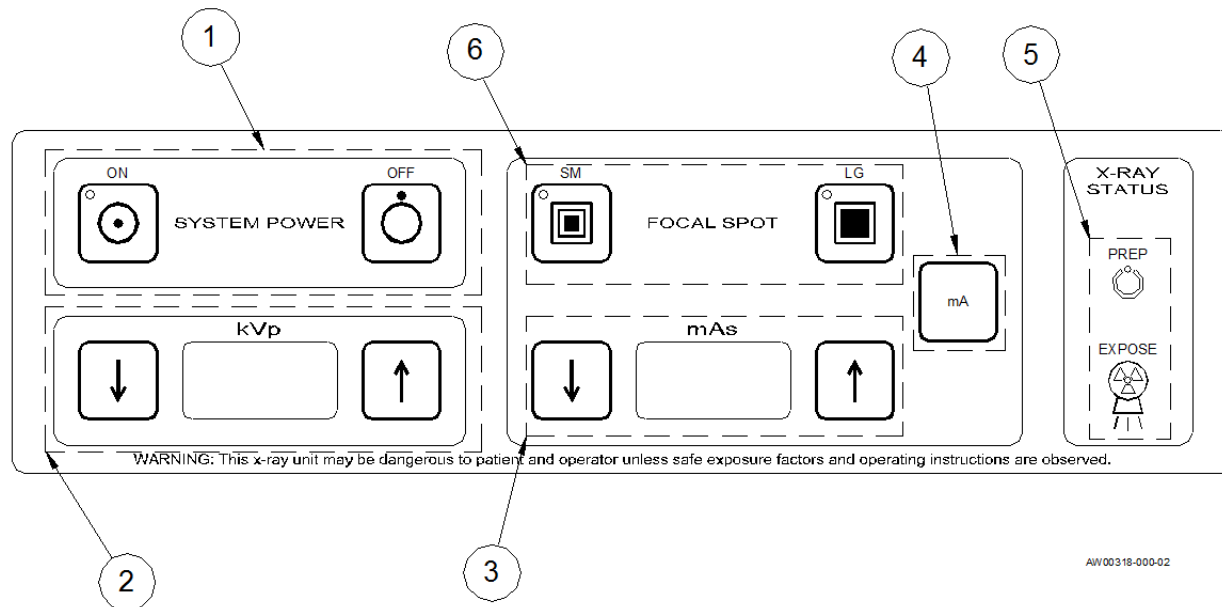

OPERATOR CONTROLS

1. Power ON and OFF buttons and POWER ON indicator LIGHT.
2. kVp digital display and kVp increase/decrease arrow buttons.
3. mAs digital display and mAs increase/decrease arrow buttons.
4. mA display button.
5. PREP indicator light. X-RAY EXPOSURE indicator light.
6. FOCAL SPOT selection buttons and indicator lights.

1 POWER, PREP AND X-RAY EXPOSURE CONTROLS

POWER ON, POWER OFF

Press to switch the x-ray generator on. A green LED will be lit when the unit is on. The console will light up and a brief self-check will be performed upon power-up. Approximately 1-2 seconds after power-up the digital display will indicate the software version.



Press to switch the generator off. If desired, the system can be programmed to turn itself off if not used within a specific amount of time. It can be set for 1 to 10 hours in one hour increments, or disabled. Contact your Summit dealer to program this feature.

2 kVp CONTROL

The kVp digital display will indicate the kVp selected. Press the UP and DOWN arrow buttons to scroll through the available kVp selection. Continuously depressing the buttons will allow the kVp to increase/decrease one kV every 1/2 second for five (5) steps and then accelerates to approximately ten (10) steps per second.

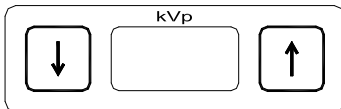

3 mAs CONTROL

The mAs digital display will indicate the mAs selected. Press the UP and DOWN arrow buttons to scroll through the available mAs selections. Continuously depressing the buttons will allow the mAs to increase/decrease one mAs selection every 1/2 second for five (5) steps and then accelerate to approximately ten (10) steps per second.

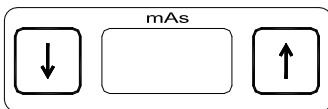

4 mA INDICATOR

Press the mA button to view the mA station to be used for the mAs selected. The mA will appear in the mAs digital display, when the mA button is depressed.



5

PREP, X-RAY EXPOSURE INDICATOR**PREP**

Partially depress the exposure footswitch to rotate the tube rotor. In approximately 1.5 – 2 seconds, the prep indicator (green LED) will light. The exposure will start when you fully depress the exposure foot switch.

EXPOSE

The x-ray exposure indicator (yellow LED) will light and an audible tone will sound when x-rays are being produced. If desired, the audible tone can be programmed for a duration of 0.25, 0.50, 0.75 or 1.00 second. Contact your Summit dealer to program this feature.

If the Exposure footswitch is released prior to fully depressing the footswitch, the exposure will be inhibited and the prep cycle will have to be restarted (does not apply to latching prep option).

If the Exposure footswitch is released during the x-ray exposure, the exposure will be terminated and an error message (E35) will be displayed.

6

FOCAL SPOT INDICATOR

The X-Ray tube focal spot can be selected. Press the appropriate button to select the preferred focal spot setting. A green LED will illuminate to indicate the focal spot selected.

- Press the SM button to select the small focal spot.
- Press the LG button to select the large focal spot.

4.5 USER CONSOLE: AP

OPERATOR CONTROL Panel

All of the generator functions are controlled by selections made at the Operator's Console. Turning the system on or off, selecting an anatomical region and specific view, selecting actual patient size, or changing exposure technique factors are all accessible from this Console. Modifying the names of anatomical regions and views, as well as the technique factors displayed with these selections can be done by the equipment user as described in this manual.

OPERATOR CONTROLS

(NOTE: Control buttons may vary from model to model.)

1. Power ON and OFF buttons and POWER ON indicator.
2. X-RAY exposure indicator.
3. IMAGE RECEPTOR selection buttons.
4. LCD display window, BACK button, and AP technique selection and programming buttons.

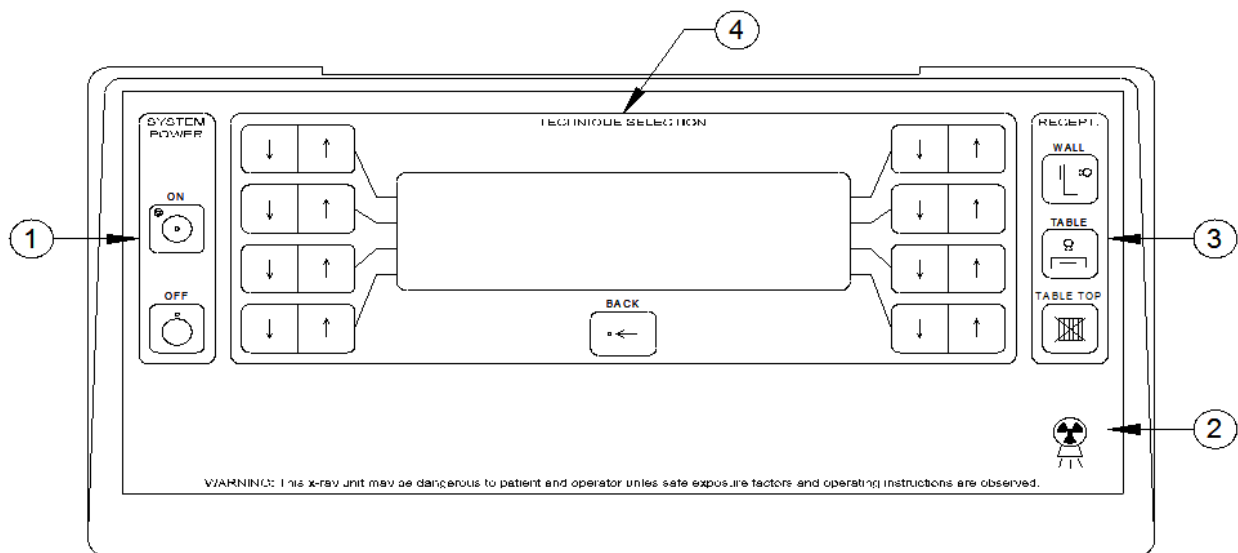

1

POWER CONTROLS

Power On, Power Off



Press ON to switch the x-ray generator on. A green LED will be lit when the unit is on. The console will light up and a brief self-check will be performed upon power-up. Approximately 1-2 seconds after power-up the digital display will indicate the software version.

A GREEN LED will be illuminated while console power is on.

Press OFF to switch the generator off.

2

X-RAY EXPOSE INDICATOR



Depress the two-position footswitch to the first position to spin the rotor. In approximately 1.5 to 2 seconds, the prep ready indicator "PREP" will appear on the LCD window. Depress the footswitch to the second position to make an x-ray exposure.

The x-ray exposure indicator (yellow LED) will light when x-rays are being produced, and an audible tone (approx. 500ms) will sound at the end of the exposure.

-If the PREP switch is released prior to depressing the EXPOSURE switch, the exposure will be inhibited and the prep cycle will have to be restarted.

-If the EXPOSURE switch is released during the x-ray exposure, the exposure will be terminated and an error message will be displayed.

- If "latching prep" is not enabled (two-position footswitch used): Pressing and holding both PREP & EXPOSURE switches will cycle the generator through prep and exposure.

- If "latching prep" is enabled (foot treadle used): Pressing and releasing the foot treadle will allow the unit to latch into prep cycle. When the prep ready indicator "PREP" appears on the LCD window, press and hold the foot treadle again to make an x-ray exposure.

- An optional remote wall exposure switch is also available.

3

IMAGE RECEPTORS

Wall Bucky, Table Bucky and Non-Bucky Image Receptor Selection

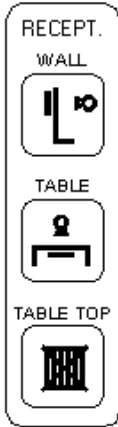

Press WALL to select the wall image receptor. (May not be present on all models.)

Press TABLE to select the table image receptor.

Press TABLE TOP for exposures used without an image receptor.

4

LCD DISPLAY WINDOW AND AP BUTTONS

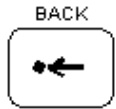

Press the BACK button to view the previous screen.

AP Regions and Views

1. Power the unit by pressing the ON button.
2. The LCD window will offer you the option of APR or 2-Point programming. Select APR by pressing the lower left-hand button.

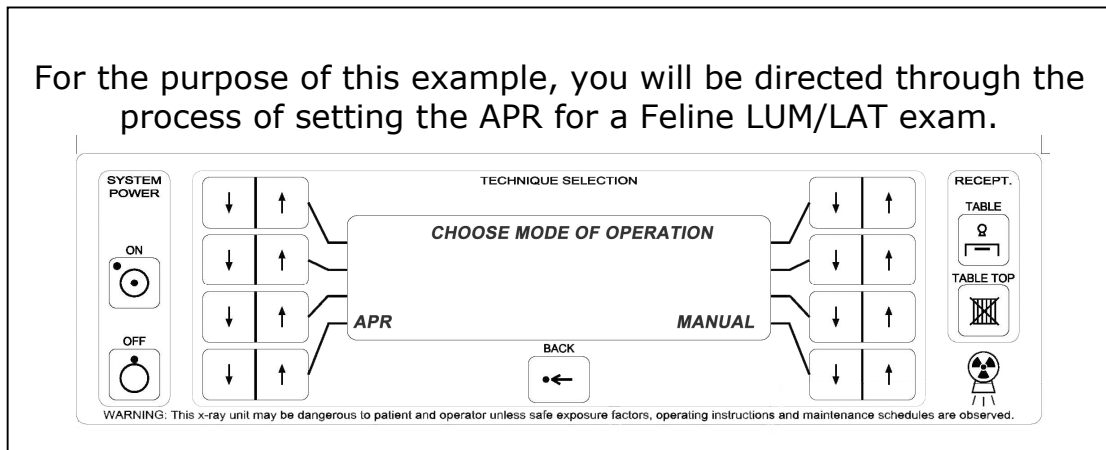

3. Select the Region by pressing the associated arrow button.

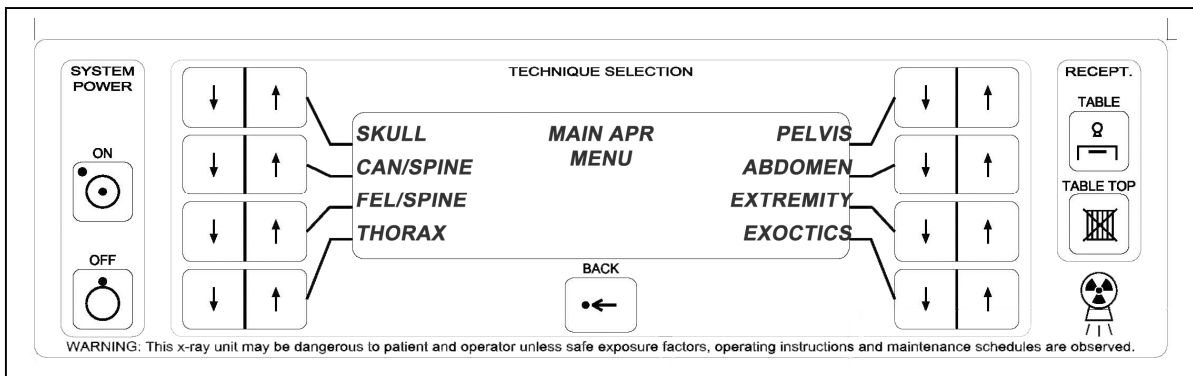

4. Once you have selected the region, select the Radiographic View by pressing the associated arrow button.

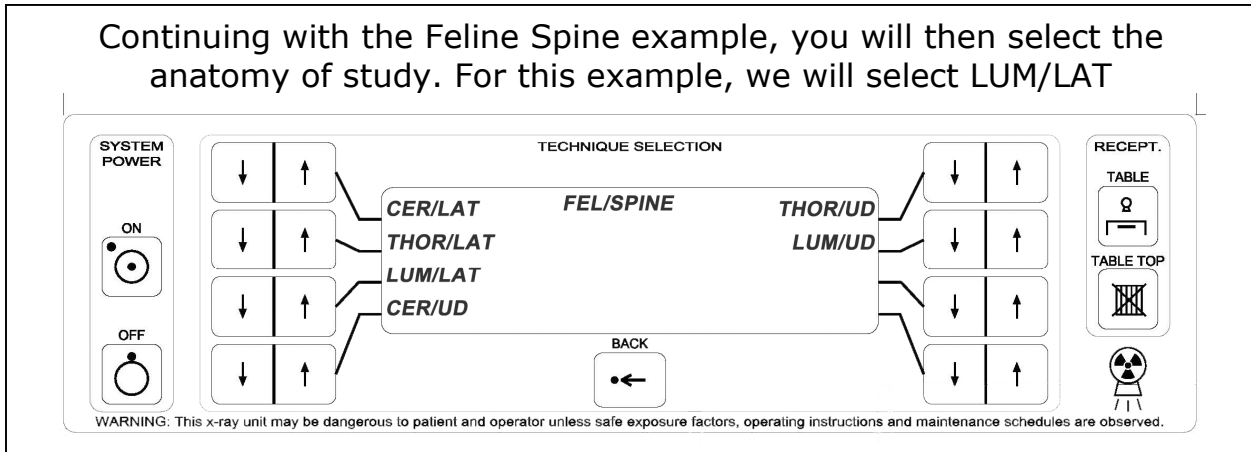

5. Once you have selected the anatomy of study, pre-programmed technique parameters (kVp, mAs, mA and Focal Spot) will appear.

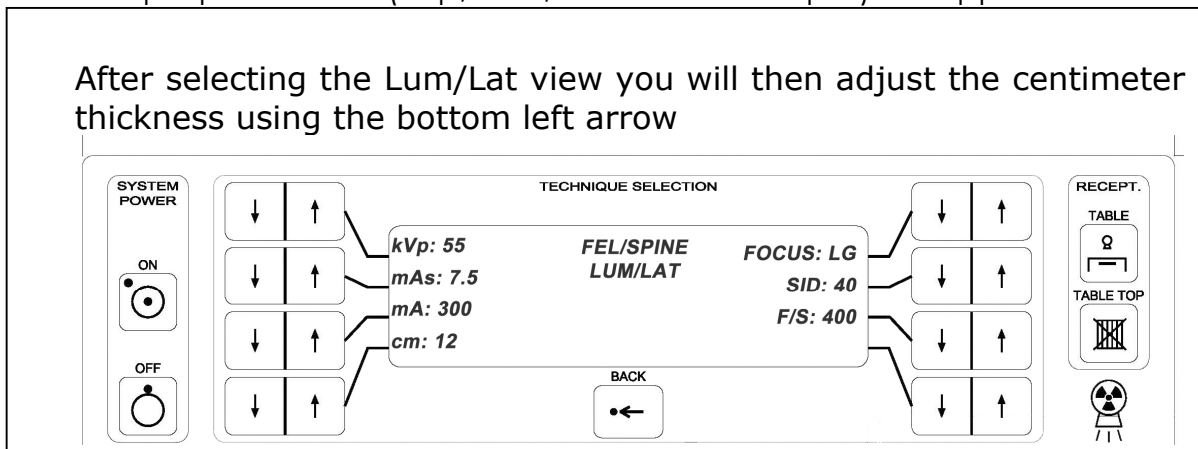

6. After measuring the patient, adjust cm thickness to correspond by pressing the lower left hand button.

- NOTE: You may override the pre-programmed settings to suit your needs.
- Press the associated arrow button to override the pre-programmed value.

Overriding of the programmed technique parameter does not affect the APR memory.

When overriding a pre-programmed technique factor (kVp or mAs), an arrow will be displayed to identify that the selected value is higher or lower than the pre-programmed technique value.

Be sure that mA or timing adjustments are done LAST. Our generators will auto-select the appropriate time/mA for the default settings if they are not the final items adjusted.

4.6 SETTING TECHNIQUES

The generator will automatically select the highest mA and shortest exposure time available to achieve the mAs displayed.

If the exposure is terminated prior to the completion of the exposure an error code will be displayed as well as the mAs produced during the exposure. Any button may be pressed to restart the operator console.

Refer to the Error Code section of this manual for further reference.

If invalid technique exposure factors are selected, an audible tone will occur and an error code will be displayed in the digital display. For example, If the mAs selected is below the lowest possible setting, the operator console will alert the operator by means of an audible tone and error code. The generator will automatically change the mAs to the minimum allowable mAs on the large focal spot.

If the small focal spot is being selected, and the mAs selected exceeds the range of the small focal spot rating of the generator and x-ray tube, the operator console will alert the operator by means of an audible tone and error code. The generator will automatically change the mAs to the maximum allowable mAs on the small focal spot (100mAs).

4.7 EXPOSURE COUNT

The HF generators keep track of how many exposures were taken. This number can be accessed by the User as follows:

kVp/mAs generators

To display exposure count:

- Press and hold **mA** button
- While holding the **mA** button, press and release the **Sm Focal Spot** button.
- The left display will show "C##", the right display will show "###". The numbers are read as follows:
 - "C12" "718" represents 12,718 exposures

To return to normal Radiographic mode:

- Wait 5 seconds.

AP generators

Start generator and select **MANUAL 2PT** mode.

The right side of LCD will display **EXP COUNT**. Press the associated button and the LCD will now show **EXP #:NNNNN** for five seconds (after which the display will go back to normal). The NNNNN represents the exposure count. For example, **EXP #:12718** represents 12,718 exposures.

To return to AP Mode, press & release the "back" button & select AP (or APR) Mode

4.8 MAKING EXPOSURES



When taking an x-ray exposure, the operator should exercise appropriate protection and operation. X-Ray is hazardous to both patient and operator if proper operation and protection is not practiced.

4.8.1 Making Exposures with the Standard Foot Switch

First, partially depress the Exposure Foot Switch until the PREP light begins to flash. This starts the tube prep cycle. After 1 to 2 seconds the prep light will continuously stay lit, and the tube is now ready for an exposure. The exposure will start when you fully depress the Exposure Foot Switch. The generator will instantaneously activate and sound an audible "beep" to indicate that an exposure was made.

If the Exposure Foot Switch is fully depressed initially and then held the unit will automatically go through its two-second prep cycle and then expose. Hence, you will note a slight pause between pressing the foot switch and hearing the exposure signal.

To time an exposure (to synchronize with a patient's breathing, for example), partially depress the Exposure Foot Switch and then wait to fully depress the switch until the precise moment when exposure is desired.

4.8.2 Making Exposures with the Optional Foot Treadle

First depress and release the Exposure Foot Treadle until the PREP light begins to flash. This starts the tube prep cycle. After 1 to 2 seconds the PREP light will continuously stay lit, and the tube is now ready for an exposure. The exposure will start when you depress the Exposure Foot Treadle again. The generator will instantaneously activate and sound an audible "BEEP" to indicate that an exposure was made.

If the Exposure Foot Treadle is initially depressed and held, the unit will automatically go through its two-second prep cycle and then expose. You will note a slight pause between pressing the foot switch and hearing the exposure signal.

To time an exposure (to synchronize with a patient's breathing, for example) depress and release the treadle to put the generator in "PREP", then depress the treadle to expose at the precise moment then exposure is desired.

After 20 seconds if no exposure is made, PREP is released and an error message (E28) will be displayed.

5.0 ERROR CODES

The control will display error codes on the digital displays during normal and abnormal operation of the unit. This section contains a table of the error codes, their descriptions, and solutions.

INVALID SETTINGS & SELECTIONS		
ERROR	AP DISPLAY	Required Action
E01	kVp LIMIT	Adjust kVp technique parameter.
E02	mAs LIMIT	Adjust mAs technique parameter.
E03	TUBE LIMIT	Adjust kVp / mAs technique parameters.
E04	kW LIMIT	Adjust kVp / mAs technique parameters.
E05	TIME LIMIT	mA/mAs combination exceeds internal timer.
E06	TIME LIMIT	mA/mAs combination exceeds internal timer.
E07	BUTTON	Button is inactive in this setting.
E08	mA LIMIT	Highest mA is already selected.
E09	cm LIMIT	Highest or lowest cm is already selected.
E18	APR DATA LMT	Selection not available or installed during system set-up.
E19	DENSITY LMT	Highest or lowest AEC density setting is already selected.
E40	NO WALL AEC	Select the image receptor with AEC installed.
E41	NO TABLE AEC	Select the image receptor with AEC installed.
E42	NO T-TOP AEC	Select the image receptor with AEC installed.
E52	CAL DATA LMT	Selection not available or installed during system set-up.
-	TUBE ANGLE	Roll tube so x-ray beam points down to the table top.

ERROR CODES		
ERROR	AP DISPLAY	Required Action
E10	MICRO-P	Turn Operator console off and on to clear. Call for service.
E11	NO COMM.	Call for service.
E12	+/-12V LIMIT	Turn Operator console off and on to clear. Call for service.
E13	EEP R/W	Turn Operator console off and on to clear. Call for service.
E14	EEP CHECKSUM	Turn Operator console off and on to clear. Call for service.
E15	PREP PRESSED	Turn Operator console off and on to clear. Call for service.
E16	EXP PRESSED	Turn Operator console off and on to clear. Call for service.
E17	SYS COOL DOWN	Heat build-up. Wait for system to cool down before using.
E20	DOOR INTLK	Verify doors are closed during x-ray exposure. If error persists, call for service.
E21	TUBE INTLK	Heat build-up. Wait for tube to cool before using.
E22	COLMTR INTLK	Not used with manual collimation. Call for service.
E23	GENRL INTLK	Call for service.
E24	FAIL KV FB	Call for service.

ERROR CODES		
ERROR	AP DISPLAY	Required Action
E25	DC BUS LOW	Turn Operator console off and on to clear. Call for service.
E26	STILL ANODE	Call for service.
E27	ANODE ROT.	Turn Operator console off and on to clear. Call for service.
E28	PREP HELD	X-Ray prep cycle too long (20 seconds prep cycle limit).
E29	NO BUCKY MOT	Improper configuration at installation. Call for service.
E30	mA PRESENT	Turn Operator console off and on to clear. Call for service.
E31	kVp PRESENT	Turn Operator console off and on to clear. Call for service.
E32	LOW FIL AMPS	Call for service.
E33	HI FIL AMPS	Call for service.
E34	IPM OVERLOAD	Turn Operator console off and on to clear. Call for service.
E35	EXP. RELEASE	X-Ray exposure was pre-terminated by Operator due to early button release.
E36	LOW AEC RAMP	Press RESET button to clear error. Increase Back-up mAs or kVp technique parameter.
E37	kVp OVERLOAD	Call for service.
E38	mA OVERLOAD	Turn Operator console off and on to clear. Call for service.
E39	BACKUP MAS	Press RESET button to clear error. Increase Back-up mAs technique parameter.
E44	KVP TOO LOW	Call for service.
E45	NO ZCO	Call for service.
E46	KEY CODE BRD	Verify if correct Key Code board for 40 or 50 kW generator is used.
E47	TUBE NOT CALIBRATED	Call for service.
E48	KV NOT CALIBRATED	Call for service.
E49	CONSOLE RST! PLS. RELEASE PREP/EXP SW!	Release prep/expose switch.
E50	CPU ERROR! WAIT FOR RST FROM CPU	Restart digital workstation.
E51	NO MEM CARD	No memory card installed.
E53	APR CHECKSUM	Call for service.
E54	INVALID GEN MOD. NO.	Call for service.
E55	AUTO CAL FAILED	Call for service.

ERROR CODES		
ERROR	AP DISPLAY	Required Action
E56	AUTO CAL / TUBE SEASON ABORTED!	Call for service.
E57	EXPOSE HELD	Release Expose switch.
E58	mA TOO LOW	Call for service.
E59	FIL I SENSOR	Call for service.
E60	CPU ERROR! COMM. ATTACK	Restart digital workstation. Call for service.
E61	mA LOW ERROR PRE-CAL (LG)	Call for service.
E62	mA LOW ERROR PRE-CAL (SM)	Call for service.
E63	mA CAL ERROR LARGE FOCUS	Call for service.
E64	mA CAL ERROR SMALL FOCUS	Call for service.
E65	mA LOW ERROR T-SEASON CHK	Call for service.
E66	mA LOW ERROR T-SEASONING	Call for service.
E67	mA LOW ERROR SYS PWR TEST	Call for service.
E68	AC LINE VOLT NOT SELECTED	Call for service.
E69	K904 VER. NOT SELECTED	Call for service.
E70	ERR. AC LINE OR K904 VER.	Call for service.
E71	mA FEEDBACK DISABLED	Call for service.
E72	mAs LIMIT FOR 208 VAC	Call for service.
E73	MAX mA LIMIT EXCEEDED	Call for service.
E74	mA NOT CALIBRATED	Call for service.

6.0 EDITING APR

(Not available on 2 PT generators)

All APR screens can be edited in the field. The menus and technique parameters can be modified and saved to memory. Once, saved to memory, all APR and calibration values can be downloaded and saved on a separate Memory Card to insure fast retrieval whenever necessary.



Only qualified personnel should have access to the edit screens, to minimize the risk of invalid or inaccurate APR technique values.

6.1 EDIT APR TECHNIQUES - Modify Technique Parameters for Radiographic Views

1. With the console power OFF, depress the BACK button.
2. While depressing the BACK button, turn the console power ON.
3. Press the associated arrow button for EDIT APR MODE.
4. By pressing the associated arrow button, select the anatomical region.
5. By pressing the associated arrow button, select the radiographic view.
6. Using the associated arrow button, select preferred mA and focal spot setting.
7. Using the associated arrow button, select the preferred SID setting.
8. Using the associated arrow button, select the preferred FILM/SCREEN speed.
9. Using the RECEPTOR button, select the preferred RECEPTOR default setting.
10. To establish the APR technique values, using the associated arrow button, select the cm START thickness measurement.
11. Using the associated UP arrow button, TOGGLE to view the cm STEP value. Using the associated arrow button, select the preferred STEP value.
12. Using the associated UP arrow button, TOGGLE to view the cm START value. Using the associated arrow buttons, select the preferred kVp and mAs value for the cm measurement displayed.
13. Using the arrow button associated with the cm value, enter the preferred kVp and mAs value for each cm value displayed. There is a total of nine (9) technique reference values to edit for each APR view.
14. To exit EDIT APR MODE, turn the console off or press the BACK button to the CAL BOOTUP screen and using the associated button, EXIT TO RAD.



When editing technique parameters, press SAVE PAGE to enter information into memory. No changes will be saved if SAVE PAGE is not selected prior to viewing a new screen/page.

6.2 EDIT APR TEXT – Text Editing

1. With the console power OFF, depress the BACK button.
 2. While depressing the BACK button, turn the console power ON.
 3. Press the associated arrow button for RENAME TECH.
 4. Using the associated arrow button with MODIFY, select the Main Menu Screen (anatomical regions) or the Region Screen (radiographic views) that requires modification.
 5. Upon displaying the preferred Screen in MODIFY, use the associated arrow button to ENTER MOD. SCREEN to edit.
 6. The text available for editing is displayed in the darkened areas. Using the associated button for SCROLL DN/UP, move the cursor (highlighted box) to the preferred text.
 7. To edit the text, use the associated button to SCROLL LT/RT through the word.
 8. Using the associated button CHANGE ALPHA, enter each letter/character to the text line. As each letter/character is modified, use the SCROLL LT/RT to continue editing the text.
 9. To exit, turn the console power off or press the BACK button to the CAL BOOTUP screen and using the associated button, EXIT TO RAD.
- To access words/text aligned on the right of the LCD window, use the SCROLL LT/RT button to move the cursor to the desired text.

6.3 STORAGE & RETRIEVAL OF APR DATA

Once APR values or text are modified and saved, Summit Industries recommends storing the new values on a digital memory card. This ensures that all the APR modifications as well as calibration information is stored external to the operator console and generator. Retrieval and reloading of the information will be fast, if the need arises.

If a Memory Card is not available, Factory Set Defaults for APR menus and technique parameters can be restored to the console's memory.

6.3.1 Factory Defaults

1. With the console power OFF, depress the BACK button.
2. While depressing the BACK button, turn the console power ON.
3. Press the associated arrow button for MEMORY FUNC.
4. Press the associated arrow button for DEFAULT.
5. By using the associated arrow button, select the factory defaults to be retrieved and saved to memory:
 - DFLT ALL APR - retrieves all factory default values for APR.
 - DFLT APR REG - retrieves factory defaults for select APR Regions.
6. Upon selecting the factory default(s) to be retrieved, using the associated arrow button, select YES to restore factory defaults, or select NO to maintain current console settings.
7. To exit, turn console power off or press the BACK button to CAL BOOTUP screen and using the associated arrow button, EXIT TO RAD.

6.3.2 Memory Card, Memory Storage

1. With the console power OFF, insert the Memory Card into the slot located on the bottom of the operator console between the angulation handles.
2. While depressing the BACK button, turn the console power ON.
3. Press the associated arrow button for MEMORY FUNC.
4. Using the associated arrow button, select CONS TO CARD.
5. Using the associated arrow button, select YES to copy APR information to the Memory Card or select NO to exit the screen.
6. Turn Off console power and remove memory card.

6.3.3 Memory Card, Memory Retrieval

1. With the console power OFF, insert the Memory Card into the slot located on the bottom of the operator console between the angulation handles.
2. While depressing the BACK button, turn the console power ON.
3. Press the associated arrow button for MEMORY FUNC.
4. Using the associated arrow button, select CARD TO CONS.
5. Using the associated arrow button, select YES to copy Memory Card APR information to the console, or select NO to exit the screen.
6. Turn OFF console power and remove memory card.

7.0 TECHNICAL DATA

7.1 RADIATION LEAKAGE (MEETS FEDERAL GOVERNMENT STANDARDS)

7.1.1 From the tube housing: less than 50 mR/hr at 1m from focal spot (@ 4mA, 125 kVp).

7.1.2 From collimator: less than 50 mR/hr at 1m (@4mA, 125kVp)

7.2 COMPONENT SPECIFICATIONS

7.2.1 Table / Tubestand

- Enclosed, integrated table. Removable 24 " x 53 " top.
- Welded base construction.
- Full-travel, lead-lined grid cabinet.
- 103-line, 8:1 aluminum grid.
- Grid cabinet/tubestand interlock.
- Attached, counterbalanced tubestand; travels full table length.
- Angulation dial and operator handles.
- Foot switch.

7.2.2 Cassette Holder

- Easy-fit, removable, ABS plastic holder.
- Accepts 8" x 10", 10" x 12" and 14" x 17" cassettes in either direction.

7.2.3 Tube

- 1.0-2.0 mm focal spots. 140,000 H.U.

7.2.4 Cables

- 12', Maxi-Flex High Voltage Cables. Federal Terminations.

7.2.5 Collimator

- Manual with light field.
- Swivel-mount.
- 90-second bulb "on" time.
- Gradual turn off warning.

7.3 OPTIONS

7.3.1 Table Options

- Two-way float table top, 58" long.
- Extended length for float top table (67" overall).
- 12" table top extension. Specify right or left (for stationary table).
- Upgrade grid to 10:1, 103 line.
- Animal restraining device.
- Cassette Storage Bin.

7.3.2 Tube / Collimator Options

- 0.6-1.5 mm; 200,000 H.U.
- Programmable lamp times - 30, 60, 90, and 120 seconds.
- "No-hands" collimator light system.

7.3.3 Other Options

- Exposure foot treadle with latching prep circuit.
- Standard manual tray with sliding jaws: Accepts all cassette sizes up to 14" x 17".

7.4 STANDARDS AND SPECIFICATIONS

APPLICABLE STANDARDS

This X-ray generator complies with the following regulatory and design standards.

- UL 60601-1
- CAN/CSA C22.2 NO601.1
- X-RAY EQUIPMENT IEC 60601-2-7
- Degree of protection against harmful ingress of water: IPXO/Ordinary.
- Degree of protection against electric shock: Class I
- Mode of operation: Continuous operation with intermittent loading (standby - exposure).
- Equipment not suitable for use in presence of a FLAMMABLE ANESTHETIC MIXTURE WITH AIR OR WITH OXYGEN OR NITROUS OXIDE.



- Degree of protection against electric shock is Type B.

While most Summit X-ray Generators are UL Classified, some are not. UL Classified X-ray Generators will display a UL Classified label on the rear surface of the X-ray Generator's Power Module. To determine if an X-ray Generator is UL Classified, please examine the rear surface of the Power Module looking for the UL mark as shown below:



OUTPUT PARAMETERS

kVp range: 40 to 125 kVp
 kVp steps: variable in 1 kVp steps
 kVp accuracy: ± (5% of selected kVp + 1 kVp)
 Rise-time (10-90%): ≤ 4 ms
 mAs accuracy: ± (10% of selected mAs + 1 mAs)

GENERATOR OUTPUT POWER	
(Note: Actual power varies depending on strength of end user power line)	
GEN. MODEL	POWER
00210 -016 thru -020, -050 02968 -009, -010	20kW
00210 -000 thru -015, -035 thru -039, -051 thru -054, -056 thru -061, -064, -065 02968 -001 thru -008, -011, -012, -015 thru -017, -019 03900 -022, -025, -026, -028 thru -031, -034 thru -036	30kW
00210 -040 thru -049, -066 thru -069 03900 -003, -004, -011, -012, -023, -024, -027, -037, -038	40kW
00210 -030 thru -034, -062, -063 02968 -013, -014, -018 03900 -007, -008, -015, -016	42kW
03901 -008 thru -011	50kW

MAS STATIONS		
GEN. MODEL	SMALL FOCAL SPOT	LARGE FOCAL SPOT
00210 -002,-005,-009,-014, -017,-019,-020,-050,-051 02968 -001,-007,-010,-012, -015,-019	0.5, 0.6, 0.7, 0.8, 0.9, 1.0, 1.2, 1.4, 1.7, 2.0, 2.5, 3.0, 3.5, 4.0, 5.0, 6.0, 7.5, 9.0, 10, 12, 15, 18, 20, 22, 26, 30, 35, 40, 45, 50, 55, 60, 65, 70, 80, 100	1.0, 1.2, 1.4, 1.7, 2.0, 2.5, 3.0, 3.5, 4.0, 5.0, 6.0, 7.5, 9.0, 10, 12, 15, 18, 20, 22, 26, 30, 35, 40, 45, 50, 55, 60, 65, 70, 80, 100, 120, 140, 160, 200, 240, 280, 300, 340, 400
00210 -000,-007,-016,-018 02968 -003,-005,-009,-011	0.2, 0.3, 0.4, 0.5, 0.6, 0.7, 0.8, 0.9, 1.0, 1.2, 1.4, 1.7, 2.0, 2.5, 3.0, 3.5, 4.0, 5.0, 6.0, 7.5, 9.0, 10, 12, 15, 18, 20, 22, 26, 30, 35, 40, 45, 50, 55, 60, 65, 70, 80, 100	0.4, 0.5, 0.6, 0.7, 0.8, 0.9, 1.0, 1.2, 1.4, 1.7, 2.0, 2.5, 3.0, 3.5, 4.0, 5.0, 6.0, 7.5, 9.0, 10, 12, 15, 18, 20, 22, 26, 30, 35, 40, 45, 50, 55, 60, 65, 70, 80, 100, 120, 140, 160, 200, 240, 280, 300, 340, 400
00210 -001,-003,-006,-008, -010,-015,-030 thru -049, -052 thru -054, -056 thru -071 02968 -002,-004,-006,-008, -013,-014,-016 thru -018 03900 -*** 03901 -***	0.2, 0.3, 0.4, 0.5, 0.6, 0.7, 0.8, 0.9, 1.0, 1.1, 1.2, 1.4, 1.6, 2.0, 2.1, 2.2, 2.4, 2.5, 2.6, 2.8, 3.0, 3.2, 3.4, 3.6, 3.8, 4.2, 4.4, 4.8, 5.0, 5.3, 5.6, 6.0, 6.3, 6.7, 7.1, 7.5, 8.0, 8.5, 9.0, 9.5, 10.0, 10.5, 11.0, 12.5, 14.0, 15.0, 16.0, 17.0, 18.0, 19.0, 20.0, 21.0, 22.0, 24.0, 25.0, 26.0, 28.0, 32.0, 34.0, 36.0, 38.0, 40.0, 42.0, 45.0, 48.0, 50.0, 53.0, 56.0, 60.0, 63.0, 67.0, 71.0, 75.0, 80.0, 85.0, 90.0, 95.0, 100	1.0, 1.1, 1.2, 1.4, 1.6, 2.0, 2.1, 2.2, 2.4, 2.5, 2.6, 2.8, 3.0, 3.2, 3.4, 3.6, 3.8, 4.2, 4.4, 4.8, 5.0, 5.3, 5.6, 6.0, 6.3, 6.7, 7.1, 7.5, 8.0, 8.5, 9.0, 9.5, 10.0, 10.5, 11.0, 12.5, 14.0, 15.0, 16.0, 17.0, 18.0, 19.0, 20.0, 21.0, 22.0, 24.0, 25.0, 26.0, 28.0, 32.0, 34.0, 36.0, 38.0, 40.0, 42.0, 45.0, 48.0, 50.0, 53.0, 56.0, 60.0, 63.0, 67.0, 71.0, 75.0, 80.0, 85.0, 90.0, 95.0, 100, 105, 110, 120, 125, 130, 140, 150, 160, 170, 180, 190, 200, 210, 220, 240, 250, 260, 280, 300, 320, 340, 360, 380, 400, 420, 450, 480, 510, 540, 570, 600

Available MA and TIME Stations

Generators	mA Stations	Time Range
00210 -002,-005,-009,-014,-017,-019,-020,-050,-051 02968 -001,-007,-010,-012,-015,-019	50S, 100S 150L,200L, 250L, 300L	Small: 0.005 - 2.000 seconds Large: 0.004 - 2.667 seconds
00210 -000,-007,-016,-018 02968 -003,-005,-009,-011	50S, 100S 100L, 300L	Small: 0.004 - 2.000 seconds Large: 0.004 - 4.000 seconds
00210 -001,-003,-006,-008,-010,-015,-030 thru -049,-052 thru -054,-056 thru -071 02968 -002,-004,-006,-008,-013,-014,-016 thru -018 03900 *** 03901 ***	50S, 100S 200L, 300L, 350L, 400L, 450L, 500L	Small: 0.004 - 2.000 seconds Large: 0.004 - 3.000 seconds

ENVIRONMENTAL SPECIFICATIONS

OPERATING

Ambient temperature ranges: 50°F (10°C) to 104°F (40°C)

Relative humidity: 30% to 75%

Atmosphere pressure ranges: 20.67 inHg (700hPa) to 31.30 inHg (1060hPa)

TRANSPORT AND STORAGE

Ambient temperature ranges: -40°F (-40°C) to 158°F (70°C)

Relative humidity: 10% to 90%

Atmosphere pressure ranges: 14.67 inHg (500hPa) to 31.30 inHg (1060hPa)



WARNING:

Due to the corrosive nature of processor chemicals, it is strongly urged that the film processor is not installed in the same room as the x-ray equipment. See the processor manual for recommendations on venting requirements for the darkroom and processor installation.

This information is provided to help you establish safe operating conditions for both you and your X-ray generator.

Do not operate this X-ray except in accordance with information included in this section, and any additional information provided by the X-ray generator manufacturer and/or competent safety authorities.

8.0 GENERATOR EXPOSURE TABLES

The following table shows normal exposure times resulting from pre-selected mAs and mA values. This table shows the ranges and interrelation of these loading factors.

EXPOSURE TIME (SEC.)
mA focal spot

mAs	50S	100S	200L	300L	350L	400L	450L	500L
0.2	0.004	X	X	X	X	X	X	X
0.3	0.006	X	X	X	X	X	X	X
0.4	0.008	0.004	X	X	X	X	X	X
0.5	0.010	0.005	X	X	X	X	X	X
0.6	0.012	0.006	X	X	X	X	X	X
0.7	0.014	0.007	X	X	X	X	X	X
0.8	0.016	0.008	0.004	X	X	X	X	X
0.9	0.018	0.009	0.004	X	X	X	X	X
1	0.020	0.010	0.005	X	X	X	X	X
1.2	0.024	0.012	0.006	0.004	X	X	X	X
1.4	0.028	0.014	0.007	0.005	0.004	X	X	X
1.7	0.034	0.017	0.008	0.006	0.005	0.004	X	X
2	0.040	0.020	0.010	0.007	0.006	0.005	0.004	0.004
2.5	0.050	0.025	0.012	0.008	0.007	0.006	0.006	0.005
3	0.060	0.030	0.015	0.010	0.009	0.007	0.007	0.006
3.5	0.070	0.035	0.017	0.012	0.010	0.009	0.008	0.007
4	0.080	0.040	0.020	0.013	0.011	0.010	0.009	0.008
5	0.100	0.050	0.025	0.017	0.014	0.012	0.011	0.010
6	0.120	0.060	0.030	0.020	0.017	0.015	0.013	0.012
7.5	0.150	0.075	0.037	0.025	0.021	0.019	0.017	X
9	0.180	0.090	0.045	0.030	0.026	0.022	0.020	X
10	0.200	0.100	0.050	0.033	0.029	0.025	0.022	X
12	0.240	0.120	0.060	0.040	0.034	0.030	X	X
15	0.300	0.150	0.075	0.050	0.043	0.037	X	X
18	0.360	0.180	0.090	0.060	0.051	0.045	X	X
20	0.400	0.200	0.100	0.067	0.057	0.050	X	X
22	0.440	0.220	0.110	0.073	0.063	0.055	X	X
26	0.520	0.260	0.130	0.087	0.074	0.065	X	X
30	0.600	0.300	0.150	0.100	0.086	0.075	X	X
35	0.700	0.350	0.175	0.117	0.100	0.087	X	X
40	0.800	0.400	0.200	0.133	0.114	0.100	X	X
45	0.900	0.450	0.225	0.150	0.129	0.112	X	X
50	1.000	0.500	0.250	0.167	0.143	X	X	X
55	1.100	0.550	0.275	0.183	0.157	X	X	X

Summit Industries LLC

60	1.200	0.600	0.300	0.200	0.171	X	X	X
65	1.300	0.650	0.325	0.217	0.186	X	X	X
70	1.400	0.700	0.350	0.233	0.200	X	X	X
80	1.600	0.800	0.400	0.267	0.229	X	X	X
100	2.000	1.000	0.500	0.333	0.286	X	X	X
120	X	X	0.600	0.400	0.343	X	X	X
140	X	X	0.700	0.467	0.400	X	X	X
160	X	X	0.800	0.533	0.457	X	X	X
200	X	X	1.000	0.667	0.571	X	X	X
240	X	X	1.200	0.800	0.686	X	X	X
280	X	X	1.400	0.933	0.800	X	X	X
300	X	X	1.500	1.000	0.857	X	X	X
350	X	X	1.750	1.167	1.000	X	X	X
400	X	X	2.000	1.333	1.143	X	X	X

9.0 TROUBLESHOOTING

9.1 ERROR MESSAGES (SEE SECTION 1.0)

9.2 NO EXPOSURE

If, after fully depressing the foot switch, there is no audible tone, your unit may not be turned on. Use the On switch to turn on power. If there is still no exposure, call a service representative.

9.3 COLLIMATOR LIGHT BULB IS BURNED OUT

When the collimator light bulb burns out, you may either call a service person for replacement/realignment or may choose to replace the bulb yourself.

The replacement bulb must be FCS type, 150 Watt at 24 V with a pin base.



WARNING #1:

DO NOT LOOK DIRECTLY INTO THE
COLLIMATOR LIGHT SOURCE AS RETINA
DAMAGE COULD RESULT.



WARNING #2:

TURN THE POWER OFF BEFORE ATTEMPTING
BULB REPLACEMENT TO AVOID POSSIBLE
ELECTRIC SHOCK.

First, remove the back cover of the collimator. The bulb is now visible.



WARNING #3:

THE BULB, WHEN LIT, GETS VERY HOT. ALLOW IT TO COOL SEVERAL MINUTES TO AVOID BURNING YOUR FINGERS.

Pull the bulb straight out from the ceramic base.



WARNING #4:

DO NOT MAKE DIRECT CONTACT WITH THE REPLACEMENT BULB AS OIL FROM YOUR FINGERS WILL CREATE HOT SPOTS ON THE BULB, WHICH SUBSEQUENTLY MAY LEAD TO CRACKING.

To avoid direct contact between bulb and fingers, the replacement bulb is normally packaged in a cellophane wrapper.

Tear open one end so that prongs are exposed; hold the glass portion, still in its wrapper, and insert the prongs into the ceramic base. Make sure that each prong is securely fastened into its socket so that the resulting light field is straight. Remove the wrapper and discard. Replace the back cover.

If the light field is out of alignment with the grid cabinet, call a service representative for re-alignment.

9.4 FULL KVP RANGE INACCESSIBLE

If this occurs, it means that incoming line voltage is too low. Call a service representative to correct.

9.5 POOR FILM QUALITY

There are many interrelated factors in the radiographic process, which impact the degree of darkening visible on a film. What follows is a list of items to check whenever you notice a significant change in film quality:

- 9.5.1 Film Processing - Has chemistry been changed recently? Is a new brand/type being used? Have developing temperatures varied? All of these factors affect film quality.
- 9.5.2 Technique - Were proper techniques used? Consult with a Summit dealer or call Summit for information on setting up a technique chart.
- 9.5.3 Screens/Cassettes - Screens within the cassettes degrade with time. They typically lose 10% of their light-emitting capability per year. It is recommended that cassettes be re-screened every five to seven years. All should be replaced at one time to maintain uniform exposure.
- 9.5.4 Film - Has a new brand/type/speed of film been used? Are you using old film beyond its expiration date? If so, technique may need to be readjusted accordingly or new film may need to be purchased.
- 9.5.5 Foot switch - If thorax/chest films are blurring more than usual, it could be that the exposure switch is being used incorrectly. See section 4.6 to find out how to make exposures so as to hit at full inspiration.

10.0 SCHEDULED MAINTENANCE

WEEKLY MAINTENANCE

X-ray Tube Seasoning - It is recommended that you season the x-ray tube once a week to prevent possible pre-mature failure of high voltage (HV) components.

Setup:

- Close the collimator blades.
- Select kVp for each exposure according to tables below.
- Select 20.0 mAs and 200 mA (Lg FS).
- **If 200 mA is not available**, select 10.0 mAs and 100 mA (Lg FS).
- Take x-ray, then wait **30** seconds **between each exposure**.
- Perform exposures 1-8.

Weekly Seasoning Chart			
wait 30s between exposures			
Exp #	kVp	mAs	mA
1	60	20.0	200
2	70		
3	80		
4	90		
5	100		
6	110		
7	120		
8	125		

OR

Weekly Seasoning Chart			
wait 30s between exposures			
Exp #	kVp	mAs	mA
1	60	10.0	100
2	70		
3	80		
4	90		
5	100		
6	110		
7	120		
8	125		

If an error occurs during the seasoning process:

- Cycle generator power.
- Leave **mAs** and **mA** the same.
- Repeat exposure with **previous kVp (lower)**. Keep reducing kVp if error continues.
- Increase kVp back to value when error first occurred and repeat exposure.
- Make note of the date, technique, and error messages for the next x-ray maintenance visit.

If an error occurs every week:

- In general, x-ray tube seasoning should not result in errors.
- If errors begin occurring weekly, then this is a sign of a failing HV component.
- Notify **your local** x-ray service company.
- Shorten the tube seasoning time to every 3-4 days, until the x-ray system has been repaired.

ROUTINE MAINTENANCE

The following schedule of maintenance is required for safety of operation, continued ease of use, and continued long life of the product.

The maintenance program should be performed only by service personnel authorized by Summit Industries. Frequency of the service should be 30 to 60 days after installation and every six months thereafter unless indicated otherwise by local codes and regulations.

10.1 X-RAY GENERATOR MAINTENANCE

Console:

- Inspect communication cables for wear, binding, and tight coupling.
- Operate all of the switches on the console and verify that they function properly. Some switches (such as AEC controls) may not be enabled.
- Note that all text and numbers on the console screen illuminate properly.

Power Module:

- Inspect internal connections for wear, binding, and tight coupling.
- Measure line voltage and verify that TB1/TB2 are set properly.
- Inspect the HF tuning capacitor (C7), located right below the Relay PCBA, for any form of deformation. A normal capacitor must have a flat top and parallel posts. If the capacitor is suspect, then it should be replaced immediately to prevent damage to other components within the generator.
- Examine the oil level of the high voltage transformer and verify that it is about $\frac{3}{4}$ in from the top of the lid.

System:

- Inspect all system cables for wear, binding, and tight coupling.
- Inspect High Voltage cables for signs of breakdown (carbon tracking), abrasion, or wear. Regrease and retighten into the HV transformer and x-ray tube.

X-Ray:

- Perform tube seasoning/calibration.
- Verify kVp and mAs outputs are within accuracy limits.
- Verify kVp and mA waveforms are of the proper amplitude and shape.
- Annually perform complete system conformance testing per section 7 of install and service manual.

10.2 X-RAY TUBE HOUSING

10.2.1 Inspect for possible oil leakage.

10.2.2 Assure that the housing is tightly fastened to the tube mount and collimator.

10.2.3 Inspect stator cable for fraying or damage.

10.2.4 Inspect high voltage cable ends for carbon tracking. Clean and re-grease HV Cable ends annually.

10.3 COLLIMATOR

10.3.1 Verify accuracy of field size.

10.3.2 Verify accuracy of light field to x-ray field alignment.

10.3.3 Check lamp on-off switch for proper operation.

10.3.4 Inspect collimator cable for fraying or damage.

10.4 TUBESTAND

10.4.1 Verify set-screws are securely holding tube arm.

10.4.2 Inspect counterweight cables for fraying or damage.

10.4.3 Inspect all tubestand movements for binding or interference.

10.5 FILM CASSETTE BIN

10.5.1 Inspect lead wrapping on inside of film bin for nicks or cuts.

10.5.2 Inspect joints for any openings.

10.5.3 Verify overall radiation protection by placing a loaded cassette into the bin and exposing the bin to a direct beam exposure.

10.6 OTHER

Inspect high voltage cable and all other cabling for damage.

11.0 CLEANING

Never use anything other than mild soap and water to clean plastic surfaces. Other cleaners may damage the plastic.

Never use any corrosive, solvent, or abrasive detergents or polishes.

Ensure that no water or other liquid can enter any equipment. This precaution prevents short circuits and corrosion foaming on components.

Methods of disinfecting used must conform to legal regulations and guidelines regarding disinfecting and explosion protection.

If disinfectants are used which form explosive mixtures of gases, these gases must have evaporated before switching ON the equipment again.

Disinfecting by spraying is not recommended because the disinfectant may enter the x-ray equipment.

If room disinfecting is done with an atomizer, it is recommended that the equipment be switched OFF, allowed to cool down and be covered with a plastic sheet. When the disinfectant mist has subsided, the plastic sheet may be removed and the equipment may be disinfected by hand wiping.